

Soldier Systems TRM
Visioning Workshop

Land Force C4ISR Strategy

LCol Walter Wood, DLR 4

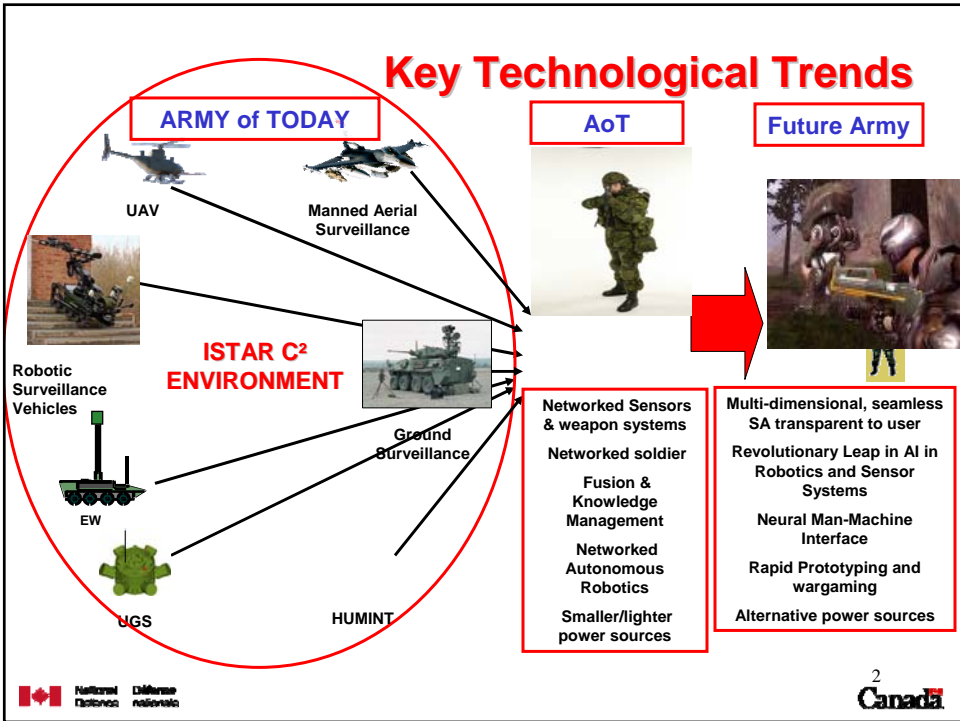



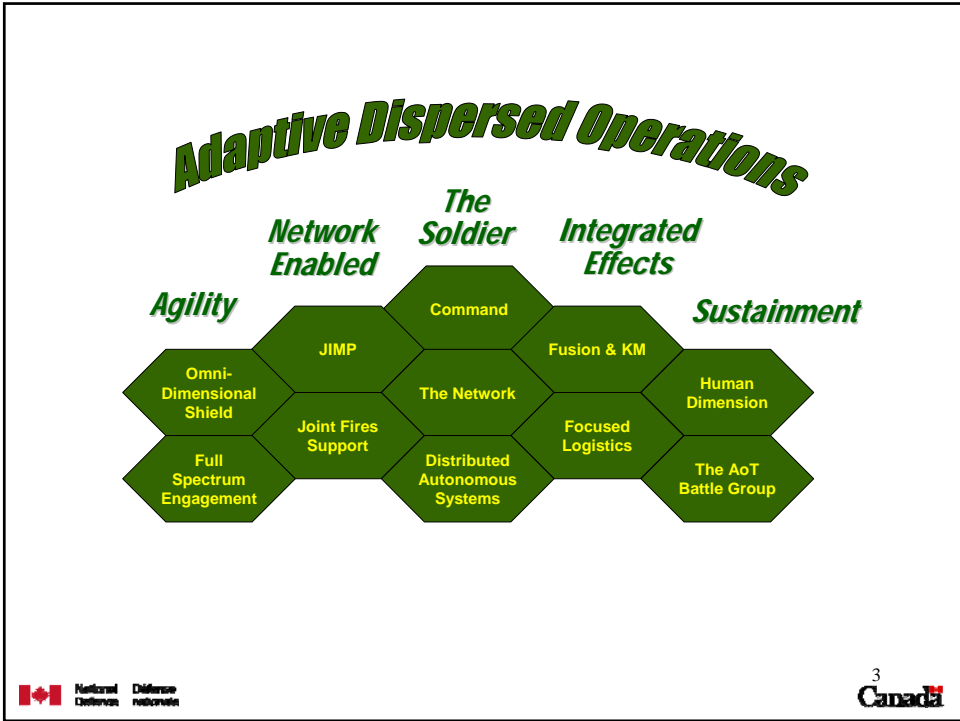



★ Functional Concept **NETWORK ENABLED**

Leveraging the military advantages that the effective integration of information systems (both technological and human) can produce through the creation and exploitation of information









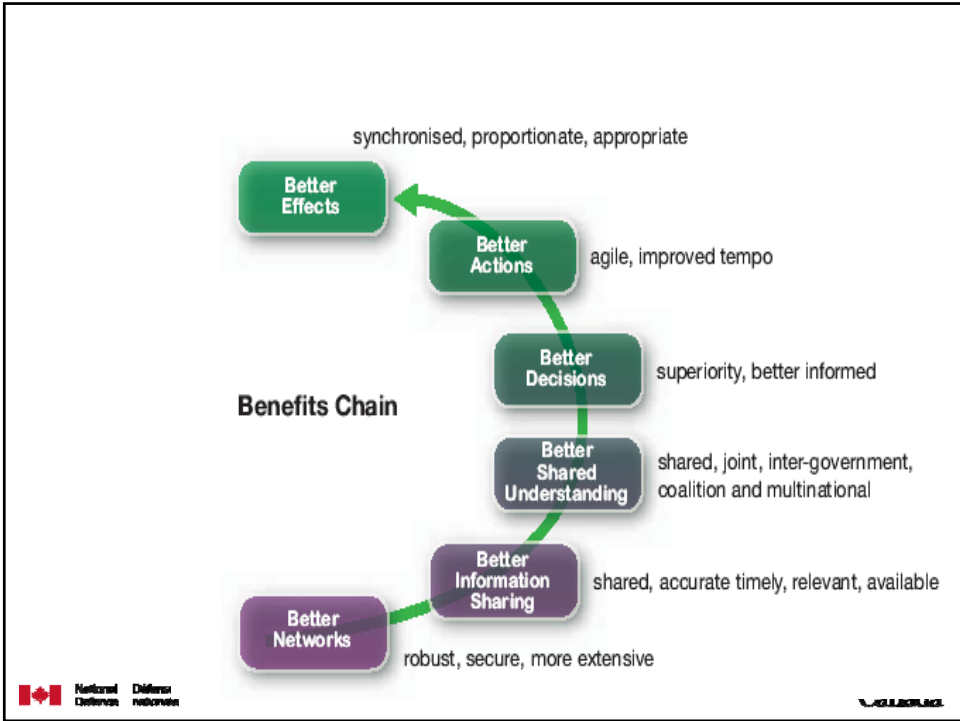

LF C4ISR Strategy

End State / "Vision":

- To enable land tactical adaptive dispersed operations (ADO) in a JIMP context by coherently and deliberately providing an evolving sustainable, fully secure, integrated, and interoperable network enabled, command centric, C4ISR capability, that is relevant and flexible to the land ops community and is synchronized with Army and CF Program objectives.

Primary impediment (Adversary CofG)
Incohérent and undisciplined effort

Army Strength (Friendly CofG)
A foundation capability from which to work
(technology, people, experience)



Delivering Coherent LF C4ISR

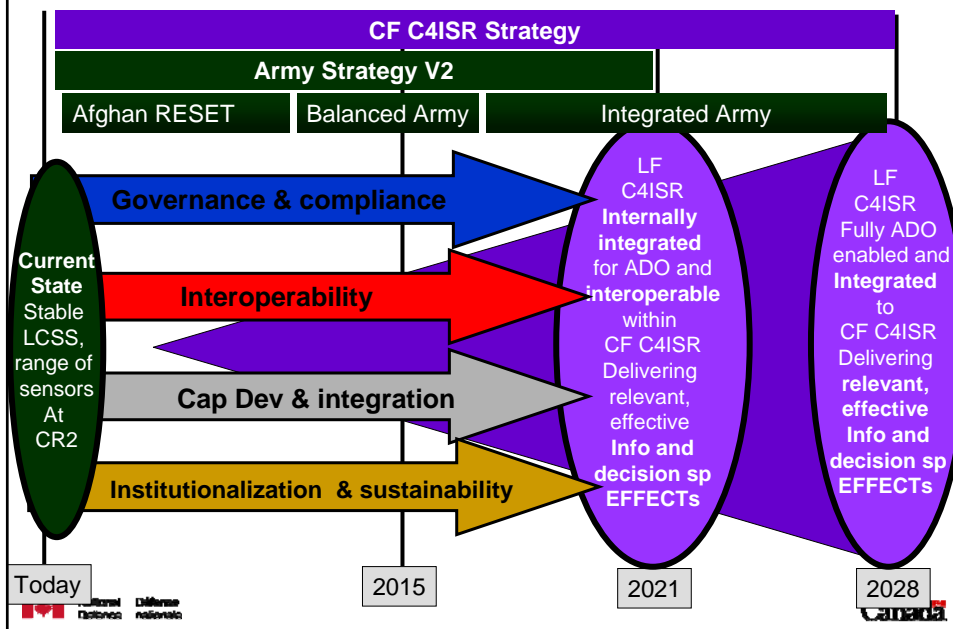

Delivering Coherent LF C4ISR

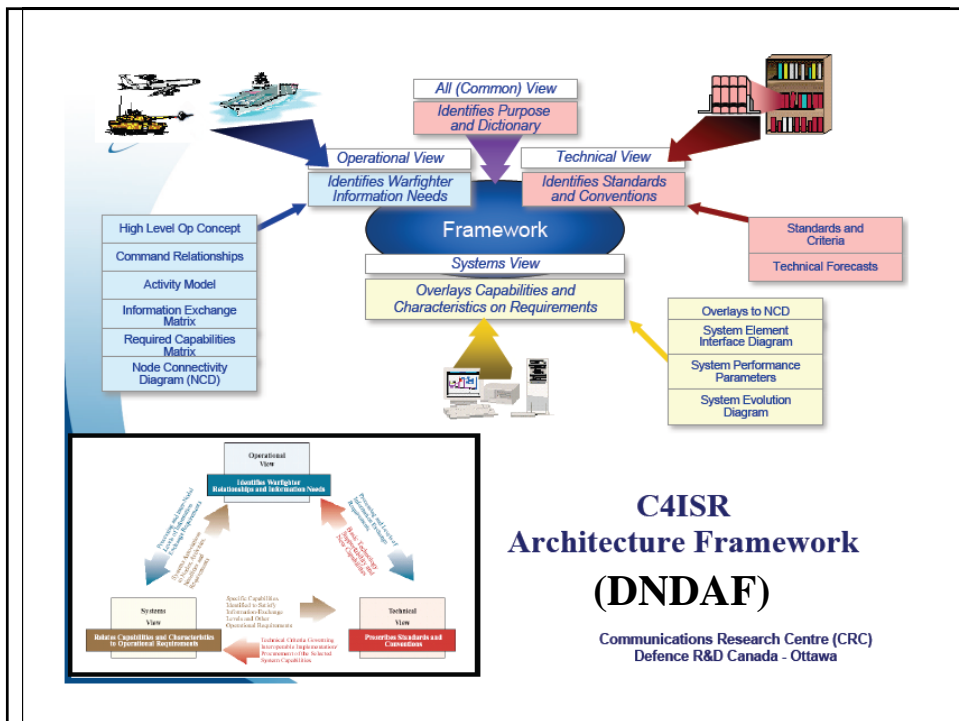
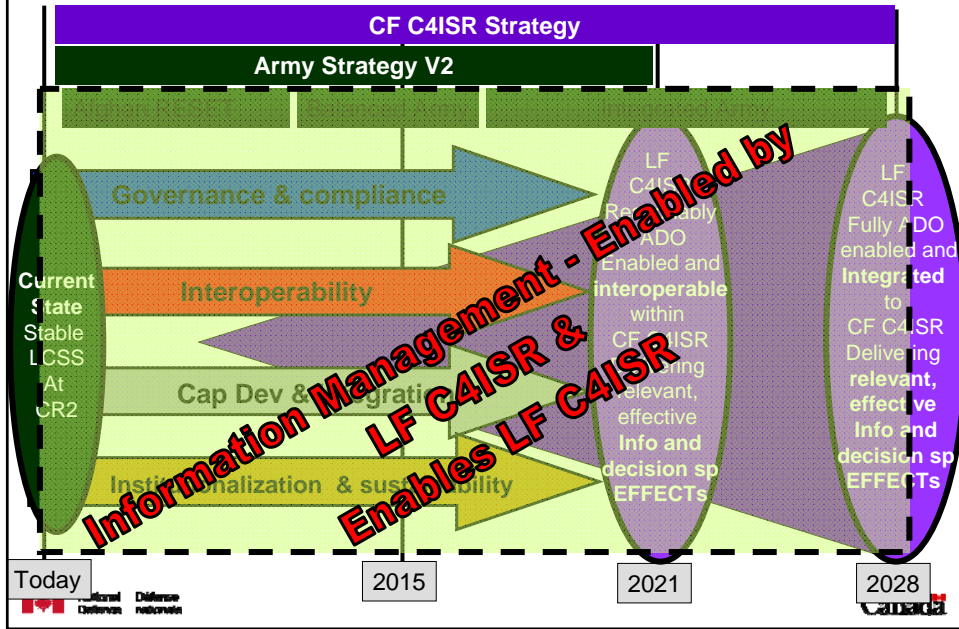

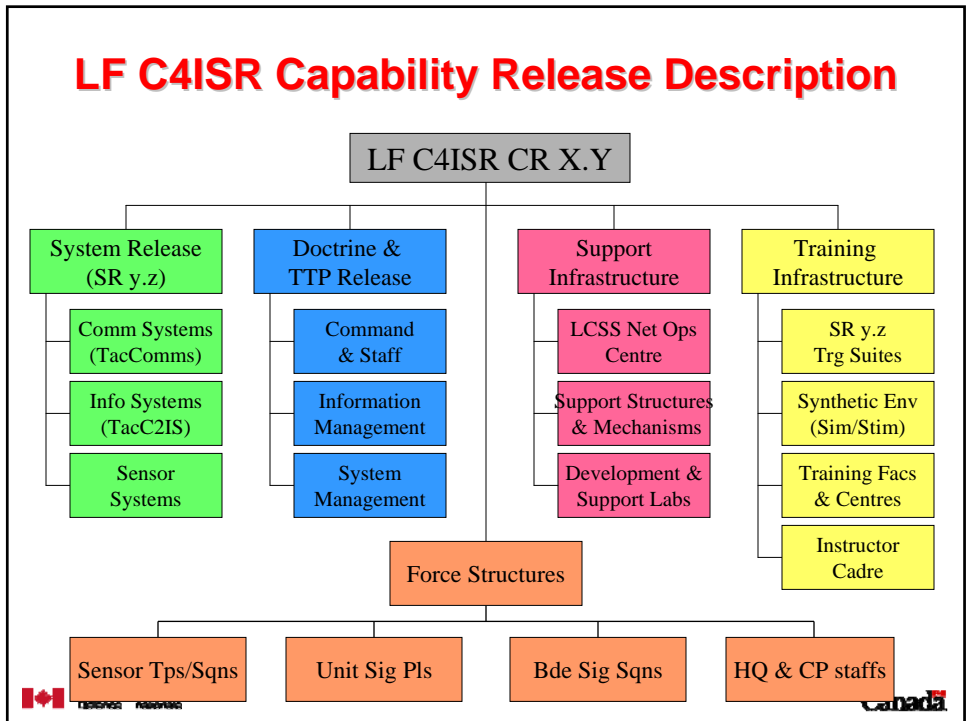
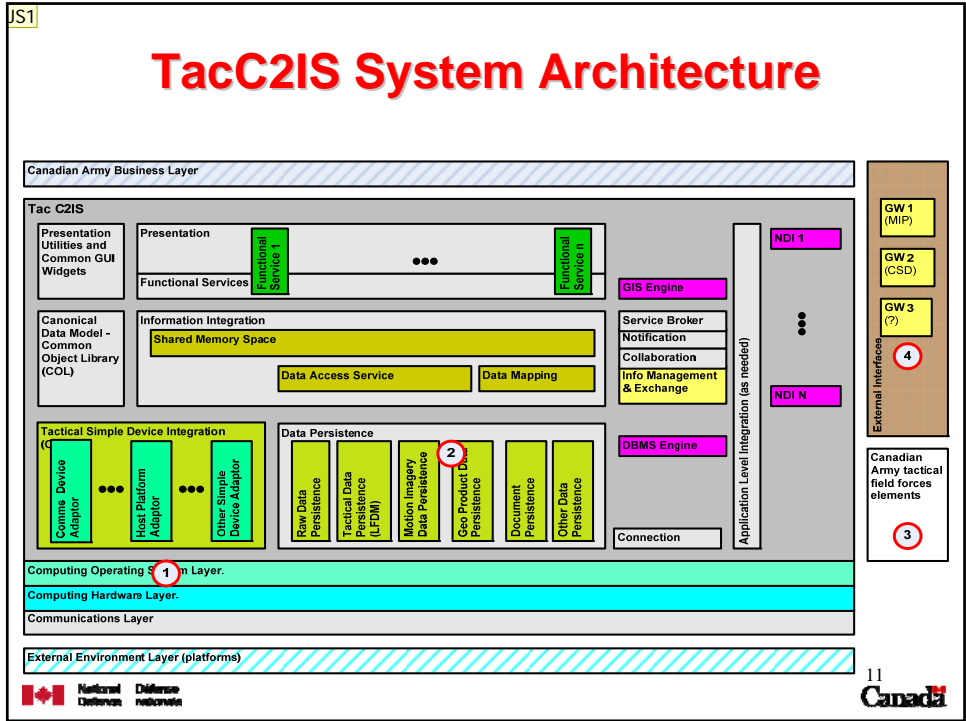

Slide 11

JS1 This diagram will need to be updated. Animation will need to be added to explain the flow of tactical information.

Johnny Slater; 2007-09-24

LF C4ISR Systems/Capabilities

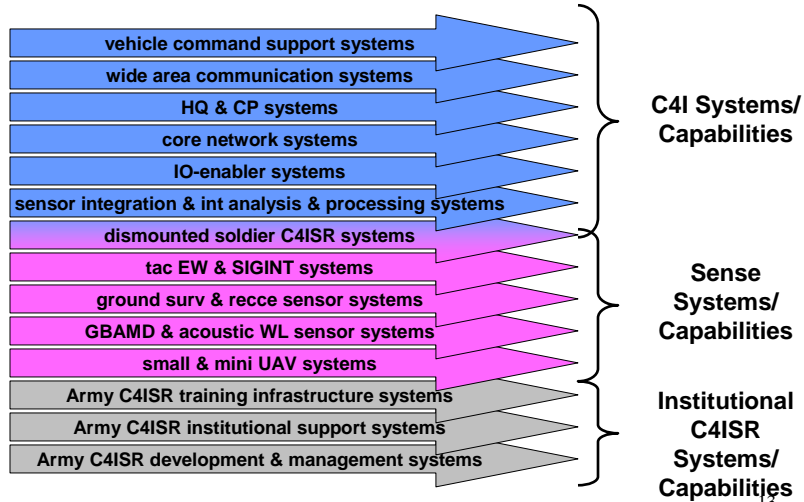

LF C4ISR Systems Development Plan

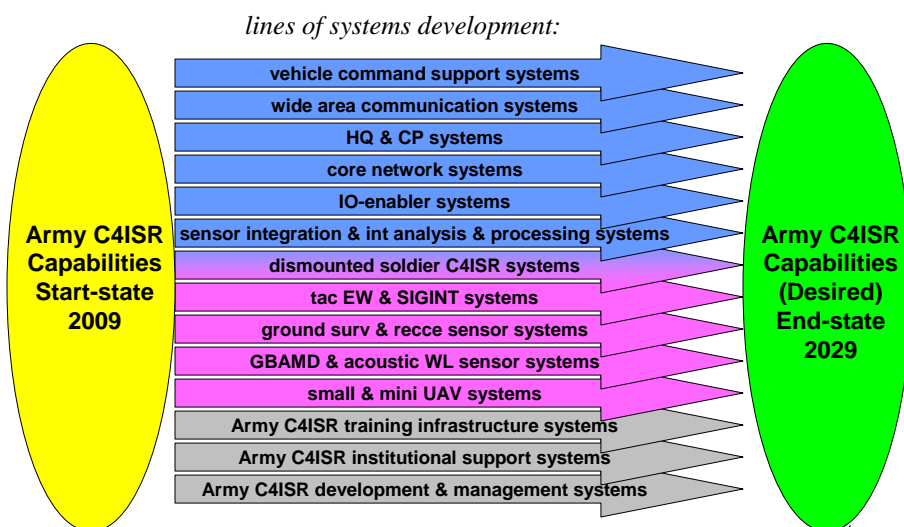

LF C4ISR Systems Development Plan

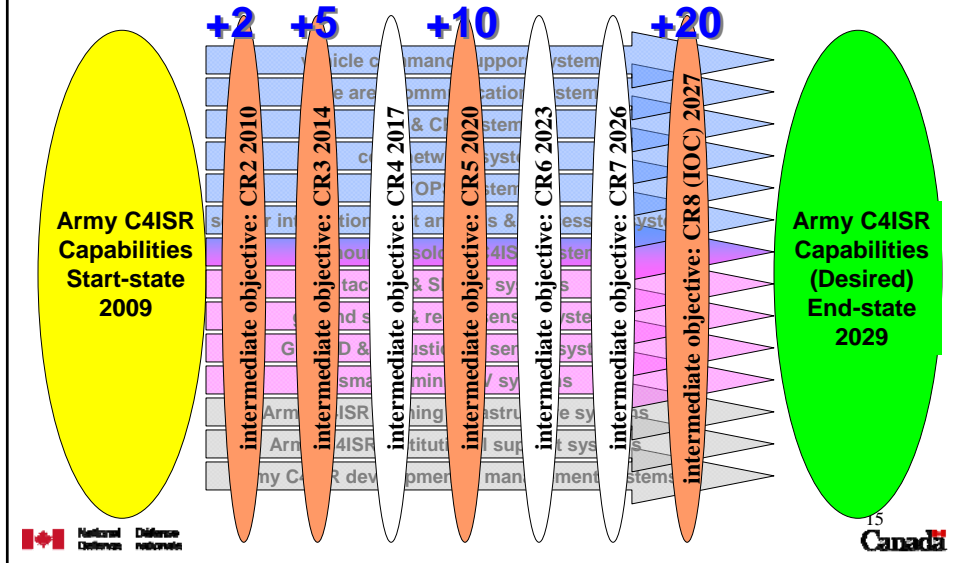

DLR OPI	Project #	Projects	Funding (\$K)	FY09-10				FY10-11				FY11-12				FY12-13				FY13-14				FY14-15				FY15-16				FY16-17				FY17-18				FY18-19											
				Q	Q	Q	Q	Q	Q	Q	Q	Q	Q	Q	Q	Q	Q	Q	Q	Q	Q	Q	Q	Q	Q	Q	Q	Q	Q	Q	Q	Q	Q	Q	Q	Q	Q	Q	Q												
ARMY C4I PROGRAM				LCSS CR 3 Fielding																LCSS CR 4 Fielding																LCSS CR 5 Fielding															
DLR 4	1012	LF ISTAR - DLC	\$101,761																																																
DLR 4	1014	LF ISTAR - C2	\$38,667																																																
DLR 4	2760	LCSS LE	\$306,723																																																
DLR 4	CLS 76	CNR Enhancement	\$55,000																																																
DLR 4	CLS 108	Wide Area Comm System Enhancement	\$60,000																																																
DLR 4	CLS 66	Tac C2IS Modernization	\$170,000																																																
DLR 4	CLS 74	Active RF Protection Systems	\$50,000																																																
DLR 4	CLS 71	LF GPS Generation 3	\$50,000																																																
DLR 4	CLS 75	LCSS Network Enhancement Ph 1	\$100,000																																																
DLR 4	CLS 67	Tactical Vehicle Radio Replacement	\$400,000																																																
DLR 4	CLS 78	LCSS Network Enhancement Ph 2	\$100,000																																																
DLR 4	CLS 97	LCSS CR7	\$250,000																																																
DLR 4	CLS 94	LCSS CR8	\$250,000																																																
DLR 4	CLS 95	LCSS CR9	\$250,000																																																
DLR 4	CLS 96	LCSS CR10	\$250,000																																																
ARMY SENSE PROGRAM																																																			
DLR 2	1015	LF ISTAR - FUAV	\$40,475																																																
DLR 2	1277	LF ISTAR - ISS Integration	\$55,620																																																
DLR 5	1675	Unit STANO	\$89,044																																																
DLR 4	1013	LF ISTAR - EW Transformation	\$78,013																																																
DLR 2	1278	LF ISTAR - MRR (remainder of WLS)	\$95,100																																																
DLR 9	1112	Enhanced Counter-IED	\$193,385																																																
DLR 3	2716	LAV Recce Surv System Upgrade	\$331,218																																																
DLR 3	2712	Mounted Cooperative Target ID	\$184,597																																																
DLR 4	CLS 75	Networked Autonomous Sensors	\$100,000																																																
DLR 2	CLS 79	ISTAR LE Cycle 1	\$50,000																																																
DLR 9		Advanced IED Detector	\$40,000																																																
DLR 4	CLS 77	LF EW 2020	\$150,000																																																
DLR 2	CLS 79	ISTAR LE Cycle 2	\$150,000																																																
DLR 4		ISTAR of the Future	\$316,000																																																
		PPA date																																																	
		EPA date																																																	

Dismounted Command Support Systems

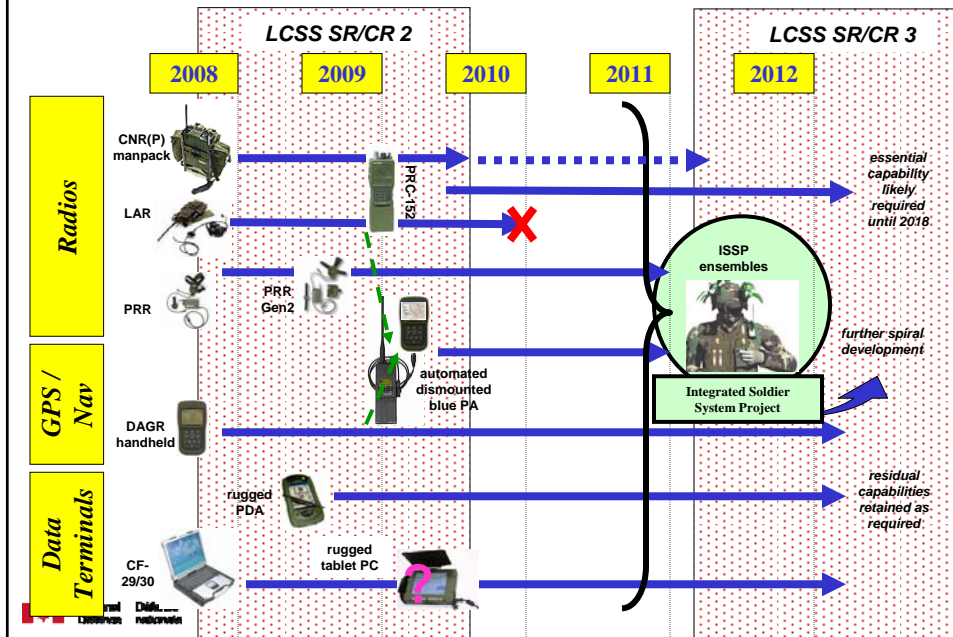

Vehicle Command Support Systems through 2018

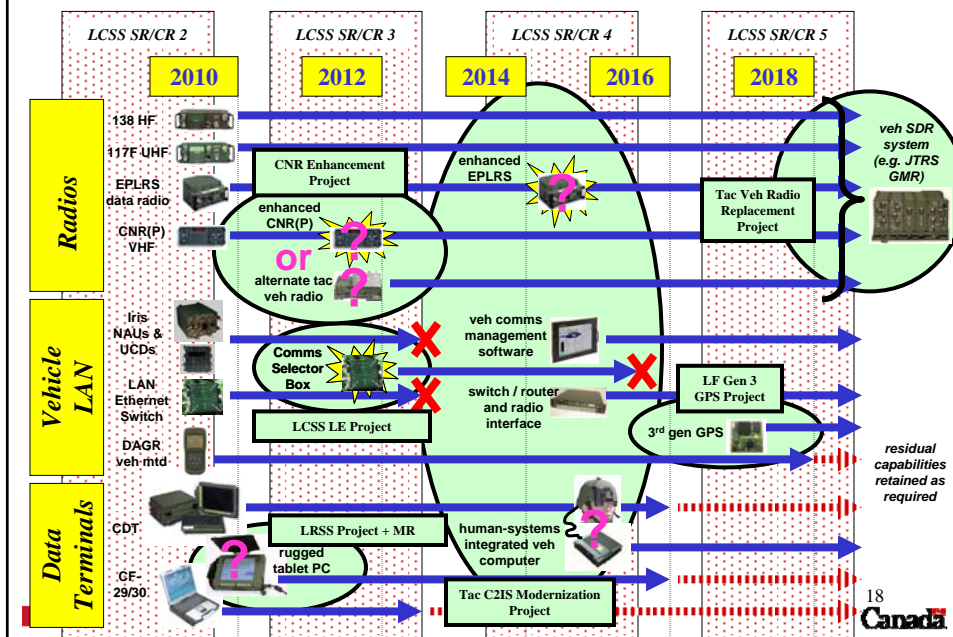

LF C4ISR Strategy Drivers & Linkages

Defence Plan / Canada First Defence Strategy

CF Objective Force 2028

CF Future Security Environment

Army Strategy

Strategic Capability Roadmap & Investment Plan

LF Force Employment Concept

DND/CF C4ISR Capability Development Strategy

LF Capabilities & Structures Model

NATO Network Enabled Capability (NNEC) &
NATO Interoperability Standards & Profiles (NISP)

Army Capital Equipment Program /
Land Capability Development Plan

Land Force C4ISR Strategy

Army IM Strategy

CF Net Ops CoE Strategy

Army Intelligence Strategy

Questions?

